











PST12/16/18TSL

Electric walkie stacker w/ straddle legs and central handle 1200, 1600 and 1800 kg maximum load capacity

INTRODUCTION

PSTSL series is tailored to suit most stacker operations with a maximum load capacity ranging between 1200 and 1800 kg. The long ergonomic steering handle guarantees the operator is at a safe distance from the stacker. In addition, stacker operations are more reliable and faster thanks to the proportional lift system.

The stacker is equipped with a standard FEM2 fork frame.

 Long handle	 Tight turning radius	 High-capacity battery	 Easy maintenance
 High performance	 Robust and reliable	 2000 kg load capacity	 CAN-BUS Technology

FEATURES

- Ergonomic central handle, compact and safe unit
- Proportional lift and lower ensure maximum precision
- Powerful maintenance-free AC Schabmüller motor
- Core components from top leading brands
- The structure has four points of contact for best stability

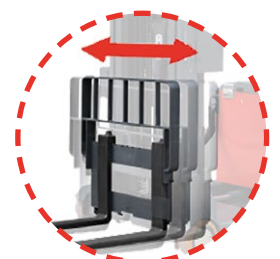

Available in option

- Sideshift function allows operators to easily reposition loads, specially on tight spaces without having to move the stacker



Standard USB port



Straddle legs

The adjustable straddle legs make it possible to maneuver any pallet and ensure greater stability. They ease the maintenance and replacement of the steering wheel when it wears out after prolonged use.



CAN-BUS technology

CAN-Bus eliminates the need for excessive wiring for high reliability. This technology eases maintenance operations diagnosis and settings, reducing maintenance downtime.

CAN-BUS



Zapi controller

The stacker is equipped with a Zapi controller and battery indicator with an hour meter and an error code display for easy maintenance.

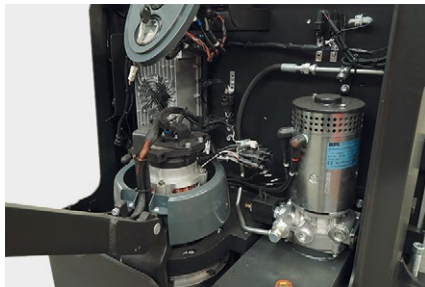

Robust and reliable design

A robust chassis and 7,6mm thick mainframe protect the stacker and its parts against impact collisions.

The stainless steel battery cover provides enhanced protection reducing maintenance costs and possible damages.

Unclean environments have less influence on the vertical AC motor because the components and brake are out of reach of direct impacts. Also, the controller is protected against dust and splash (IP 54).

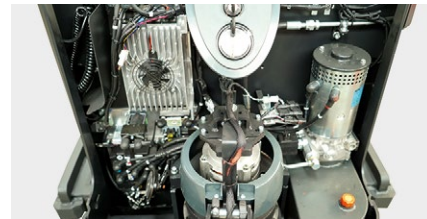

Optimized maintenance

The pallet truck and its parts have been specially designed to perform maintenance and service with ease. With only two screws, the cowl can be easily removed for easy access to all components. Wheels and rollers can be easily replaced without a lifting device.

Proportional lift / lower system

The electronically controlled proportional lift and lower system ensures accurate fork positioning and stacking operations at each height. Proportional lift increases productivity, especially when stacking heights are high.

A matching battery capacity for each application

- PS12TSL: 24 volt 180 Ah
- PS16TSL/PS18TSL: 24 volt 270 Ah

HIGH-END COMPONENTS



Multifunctional Rema handle with ergonomic contactless rocker-switches
(German)



AC Schabmüller traction motor
(German)



ZF drive unit
(German)

Intorq brakes
(German)



Rader Vogel steering wheels
(German)

Zapi electronic controllers
(Italian)



HPI hydraulics
(French)

SPE or ATIB chargers
(Italian)



High-end components reduce maintenance costs and guarantee high performance and reliability when performing the most intense operations.

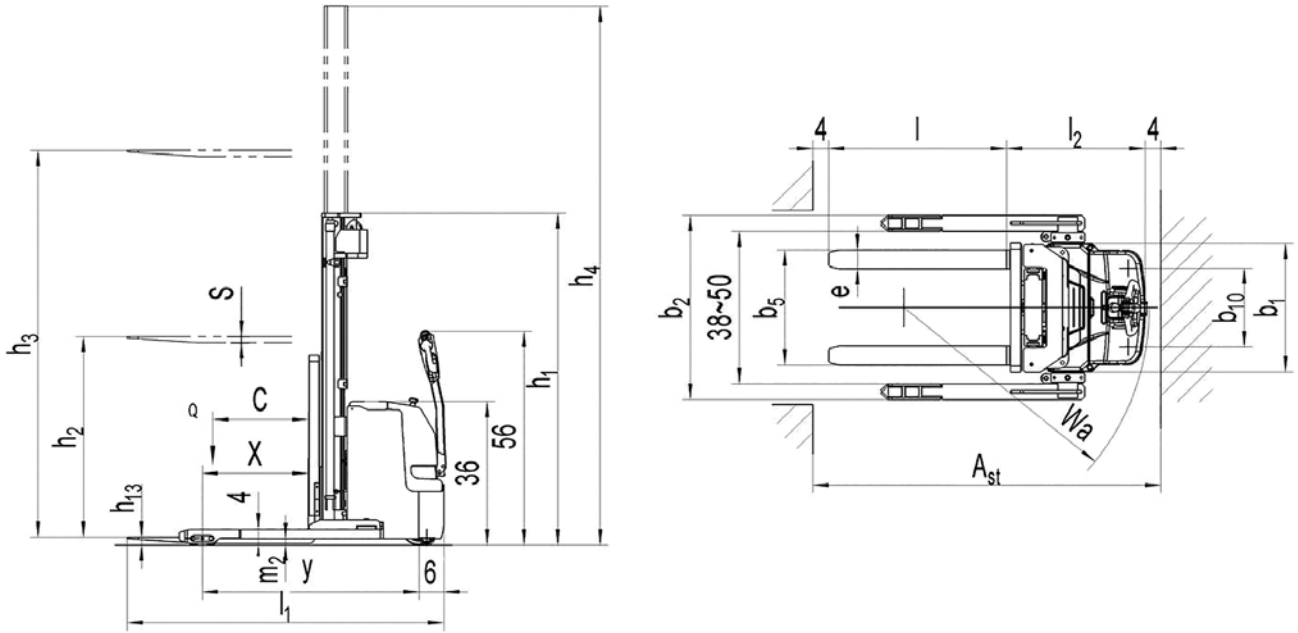

Stockman Reference	Mast	Mast lowered height h_1 (mm)	Free lift h_2 (mm)	Standard lift h_3 (mm)	Mast raised height h_4 (mm)	Weight (kg)
PSI2T SL						
PSI2TSL29	Duplex FFL	1958	1410	2830	3380	1225
PSI2TSL32		2108	1560	3130	3680	1239
PSI2TSL36		2308	1760	3530	4080	1190
PSI6T SL						
PSI6TSL29	Duplex FFL	1958	1410	2830	3380	1225
PSI6TSL32		2108	1560	3130	3680	1405
PSI6TSL36		2308	1760	3530	4080	1435
PSI6TSL40	Triplex FFL	1908	1320	3930	4480	1455
PSI6TSL43		2008	1420	4230	4780	1470
PSI6TSL46		2108	1520	4530	5080	1480
PSI6TSL53		2343	1756	5230	5780	1520
PSI8T SL						
PSI8TSL27	Duplex FFL	1978	1310	2630	3300	1435
PSI8TSL29		2078	1410	2830	3500	1455
PSI8TSL32		2228	1560	3130	3800	1485
PSI8TSL36		2428	1760	3530	4200	1515
PSI8TSL40	Triplex FFL	1978	1310	3930	4600	1535
PSI8TSL43		2128	1420	4230	4900	1550
PSI8TSL46		2228	1520	4530	5200	1560

Technical data according to VDI 2198 regulation						
Specifications	1.2	Product Reference ♦ Model		PS12T SL	PS16T SL	PS18T SL
	1.3	Power supply		battery	battery	battery
	1.4	Operator type		pedestrian		
	1.5	Load capacity	Q(t)	1,2	1,6	1,8
	1.6	Load center distance	c(mm)	600	600 ⁽¹⁾	600 ⁽¹⁾
	1.8	Distance from carriage to caster axle	x(mm)	647	664 ⁽²⁾	647 ⁽²⁾
	1.9	Wheelbase	y(mm)	1331	1378	1378
Weight	2.1	Weight (batteries included)	kg	see table opposite		
	2.2	Axle load laden front/rear	kg	774/1598	827/2253	892/2378
	2.3	Axle load unladen front/rear	kg	796/394	864/616	924/636
Wheels	3.1	Wheels		polyurethane (PU)		
	3.2	Steering wheel dimensions	Øxw(mm)	Ø230x70	Ø230x70	Ø230x70
	3.3	Load rollers dimensions	Øxw(mm)	Ø84x70	Ø84x70	Ø84x70
	3.4	Stabilizing rollers dimensions	Øxw(mm)	Ø100x40	Ø100x40	Ø100x40
	3.5	Number of front/rear wheels (x=driving wheel)		1x+2/4	1x+2/4	1x+2/4
	3.6	Front axle wheelbase	b10(mm)	500	500	500
Dimensions	4.2	Mast lowered height	h1(mm)	see table opposite		
	4.3	Free lift	h2(mm)	see table opposite		
	4.4	Standard lift	h3(mm)	see table opposite		
	4.5	Mast raised height	h4(mm)	see table opposite		
	4.9	Tiller height in drive position min/max	h14(mm)	890/1420	890/1420	890/1420
	4.15	Fork lowered height	h13(mm)	50	50	50
	4.19	Overall length	l1(mm)	1990	2075	2092
	4.20	Front axle to fork face length	l2(mm)	840	925	942
	4.21	Overall width	b1/b2(mm)	816/1170 - 1470		
	4.22	Fork dimensions	s/e/l1(mm)	35/100/1150	40/120/1150	60/180/1150
	4.25	Width across forks	b5(mm)	235/710	255/730	255/730
	4.32	Ground clearance	m2(mm)	40	40	40
	4.33	Aisle width for 1000x1200 mm pallets crossways	Ast(mm)	2396	2437	2446
4.34	Aisle width for 800x1200 mm pallets lengthways	Ast(mm)	2382	2418	2432	
4.35	Turning radius	Wa(mm)	1500	1550	1550	
Performances	5.1	Travel speed, laden/unladen	km/h	5,5/6	5,7/6	5,4/6
	5.2	Lift speed, laden/unladen	m/s	90/140	130/180	130/180
	5.3	Lowering speed, laden/unladen	m/s	200/250	140/200	140/200
	5.8	Gradeability laden/unladen	%	6/12	6/12	6/10
	5.10	Service brake		electromagnetic		
Electrical system	6.1	Drive motor rating S2 60min	kW	1,3	1,4	1,4
	6.2	Lift motor rating at S3 15%	kW	1,5	3,2	3,2
	6.3	Battery acc. to DIN 43531 / 35 / 36 A, B, C, No		2PZB	3VBS	3VBS
	6.4	Battery voltage, nominal capacity K5	V/Ah	24/180	24/270	24/270
	6.5	Battery weight	kg	175	270	270
	6.6	Energy consumption acc. to VDI cycle	kWh/h	0,95	1,59	1,7
Additional data	8.1	Type of drive control		AC - speed control		
	8.4	Noise level at driver's ear acc. to EN12053	dB(A)	<70	<70	<70

⁽¹⁾ When side-shifting, the load center distance is 500 mm

⁽²⁾ When side-shifting, the load center distance is 55mm shorter

RESIDUAL CAPACITY

SX ♦ Single

DX ♦ Duplex

TX ♦ Triplex

SL ♦ Straddle legs

FFL ♦ Full free lift

LI ♦ Initial lift

LP ♦ Proportional lift

DA ♦ Electrical power steering

SC ♦ Built-in weighing scale

CP ♦ Pin code

PS16TSL ♦ PP. 124 TO 127

PS16TSL29 DX
 PS16TSL32 DX
 PS16TSL36 DX
 PS16TSL40 TX
 PS16TSL43 TX
 PS16TSL46 TX
 PS16TSL53 TX



PS16TSL29 DX

h3 (mm)	Q (kg)	
2900	1400	1100
2500	1600	1200

cdg (mm)	600	700
----------	-----	-----

PS16TSL32 DX

h3 (mm)	Q (kg)	
3200	1200	900
2900	1400	1100
2500	1600	1200

cdg (mm)	600	700
----------	-----	-----

PS16TSL36 DX

h3 (mm)	Q (kg)	
3600	1000	700
3200	1200	900
2900	1400	1100
2500	1600	1200

cdg (mm)	600	700
----------	-----	-----

PS16TSL40 TX

h3 (mm)	Q (kg)	
4000	950	650
3600	1000	700
3200	1200	900
2900	1400	1100
2500	1600	1200

cdg (mm)	600	700
----------	-----	-----

PS16TSL43 TX

h3 (mm)	Q (kg)	
4300	900	600
4000	950	650
3600	1000	700
3200	1200	900
2900	1400	1100
2500	1600	1200

cdg (mm)	600	700
----------	-----	-----

PS16TSL46 TX

h3 (mm)	Q (kg)	
4600	800	500
4300	900	600
4000	950	650
3600	1000	700
3200	1200	900
2900	1400	1100
2500	1600	1200

cdg (mm)	600	700
----------	-----	-----

PS16TSL53 TX

h3 (mm)	Q (kg)	
5300	700	400
4600	800	500
4300	900	600
3600	1000	700
3200	1200	900
2900	1400	1100
2500	1600	1200

cdg (mm)	600	700
----------	-----	-----